

**Code Subsidiary Document**

**No. 0101:**

**Registration: New Supply Points**

## Change History

Version Number	Date of Issue	Reason For Change	Change Control Reference	Sections Affected
<u>V2.0</u>	<u>2<sup>nd</sup> October 2017</u>	<u>CSD 0101 Clarification</u>	<u>CPW015</u>	<u>2.2.22, 2.2.32 (a), 2.2.33, 3.2.2, A.2 (b), A.2 (o)</u>

## Table of Contents

1.	Introduction.....	5
1.1	Overview.....	5
1.2	Purpose .....	5
1.3	Scope .....	5
1.4	Process overview.....	6
2.	Registration of New Supply Points .....	8
2.1	Introduction.....	8
2.2	Description of process steps .....	9
3.	Monitoring, reporting, correcting and completing the Registration of New Supply Points .....	24
3.1	Monitoring and reporting .....	24
3.2	Correcting and completing the Registration of New Supply Points .....	24
4.	Process Diagrams .....	25
5.	Interface and timetable requirements.....	28
A.	Appendix: Validation checks .....	36
A.1	Introduction.....	36
A.2	Validation.....	36
B.	Appendix: process flowchart symbols .....	38

## Definitions

Unless expressly stated otherwise, for the purposes of this CSD:

- (a) terms defined in the Wholesale-Retail Code Part 1 (Objectives, Principles and Definitions) shall apply; and
- (b) capitalised terms relating to the titles of Data Items or Data Transactions described in CSD 0301 (Data Catalogue) shall have the meaning attributed therein.

# 1. Introduction

## 1.1 Overview

1.1.1 It is essential to manage the timely Registration of New Supply Points with the Market Operator. The relevant information must reach the Market Operator in good time to ensure that:

- (a) the Market Operator can create a SPID;
- (b) the Partial Registration Application can be submitted by the Retailer;
- (c) meter(s) information and the Initial Read(s) can be notified;
- (d) Service Components can be notified so that Primary Charges can commence from the appropriate date;
- (e) the Wholesaler can confirm the date of connection; and
- (f) other required information can be provided by the Wholesaler and Retailer as relevant.

1.1.2 The Registration of a New Supply Point is triggered by the Wholesaler submitting a new SPID request to the Market Operator in accordance with the Operational Terms Parts A or C.

## 1.2 Purpose

1.2.1 This CSD describes the process to be followed in order to Register New Supply Points, from the point of the Wholesaler's submission of the request for a SPID in accordance with the Operational Terms Parts A or C, through the Market Operator creating the new SPID and the Retailer submitting a Partial Registration Application, before the necessary SPID Data is completed by the Wholesaler and Retailer as relevant and the SPID becomes Tradable.

## 1.3 Scope

1.3.1 This CSD describes the process for the Registration of New Supply Points required:

- (a) for new connections;

- (b) due to Entry Change of Use (for example due to splitting of a single Eligible Premises into two Eligible Premises, or the conversion of a Household Premises into an Eligible Premises); and
- (c) due to Gap Sites being Registered.

## 1.4 Process overview

1.4.1 The guiding principles for this process are as follows:

- (a) each New Supply Point is always Registered individually by the Wholesaler, so the Water Services Wholesaler will always register the new Water Services Supply Point and the Sewerage Services Wholesaler will always register the new Sewerage Services Supply Point at an Eligible Premises;
- (b) if a SPID of the other Service Category already exists at an Eligible Premises or is in the process of being Registered, the Wholesaler Registering the New Supply Point must provide information to the Market Operator to allow the SPID at the New Supply Point to be paired with the SPID of the other Service Category which either already exists or is in the process of being Registered;
- (c) the Wholesaler Registering the New Supply Point must provide information to allow the Market Operator to confirm provision of any services of the other Service Category with the Other Wholesaler, if no SPID of the other Service Category already exists or is in the process of being Registered; and
- (d) both the Water Services Supply Point and the Sewerage Services Supply Point will become Tradable independent of each other, and Primary Charges will be applicable from their respective individual Supply Point Effective From Date.

1.4.2 The process descriptions should be read in conjunction with the process diagram in Section 4 and the interface and timetable requirements in Section 5. The step references appear beside each action or decision symbol in the process diagram. References shown thus TXXX.W relate to the associated Data Transaction, as set out in the CSD 0301 (Data Catalogue).

1.4.3 Where the process describes notifying other relevant Trading Parties, the following applies:

- (a) where the Wholesaler and the Other Wholesaler is the same Trading Party, only one (1) notifying Data Transaction is sent to the Wholesaler by the Market Operator;
- (b) where the Retailer and the Other Retailer is the same Trading Party, only one (1) notifying Data Transaction is sent to the Retailer by the Market Operator; and
- (c) where a SPID is not paired, there is no Other Wholesaler or Other Retailer, so no notifications are sent to such Trading Parties.

1.4.4 The Market Operator responds to all Data Transactions submitted by Trading Parties with a T109.M (Accept or Reject). The T109.M notifies either rejection of the Data Transaction submitted or acceptance of the Data Transaction submitted. If the Data Transaction is rejected an appropriate error code is provided in the T109.M. If the Data Transaction is accepted and the Market Operator needs to provide additional information back to the Trading Party, it will send the relevant information in a different Data Transaction in addition to the T109.M sent to notify acceptance. For simplicity of presentation, the T109.M may not be identified explicitly in the process steps, process diagrams and interface and timetable requirements.

## 2. Registration of New Supply Points

### 2.1 Introduction

2.1.1 Parts A and C of the Operational Terms set out the steps to be followed by the Wholesaler and the Retailer leading up to the Registration of New Supply Points. This section sets out the process that the Wholesaler, Retailer and the Market Operator will follow in respect of the Registration of a New Supply Point.

2.1.2 For the avoidance of doubt, if a Wholesaler either adds a new Service Component to an existing Supply Point which is Registered to that Wholesaler, or adds another meter to an existing Supply Point which is Registered to that Wholesaler, then a New Supply Point shall not be Registered; rather additions shall be made to the existing Supply Point in accordance with CSD 0104 (Maintain SPID Data).

2.1.3 The guiding principles for this process are as follows:

- (a) the Wholesaler shall submit the request for the new SPID;
- (b) the Wholesaler shall provide the Market Operator with the necessary SPID Data in respect of the Service Components applicable at the SPID. The possible Service Components are detailed in CSD 0207 (Charge Calculation, Allocation and Aggregation) and CSD 0301 (Data Catalogue);
- (c) the Wholesaler shall provide the Market Operator with Tariff details for all Service Components present at the Supply Point;
- (d) the Wholesaler shall provide the Market Operator with details in respect of any Special Agreement applicable at each Service Component at the Supply Point;
- (e) the Wholesaler shall provide the Market Operator with the necessary meter details and Initial Read for Metered Service Components for all relevant types of meter installed in relation to the Supply Point;
- (f) the Retailer should submit the Yearly Volume Estimate for a Metered Service Component;



- (g) the Wholesaler shall provide the Market Operator with relevant details required for Assessed or Unmeasured Service Components (e.g. Assessed Volumetric Rate, Water Chargeable Meter Size);
- (h) in the event that Trade Effluent Service Components are required, the Wholesaler shall provide the Market Operator with the Trade Effluent data in accordance with CSD 0206 (Trade Effluent Processes);
- (i) in the event that a meter installed at the Supply Point is in a Meter Network, the Wholesaler shall provide the Market Operator with the Meter Network data;
- (j) during the period of the partial Registration, the Retailer shall provide the Market Operator with SPID Data for which they are the Data Owner (e.g. Customer Name, Customer Classification, SIC Code, Customer Banner Name, Billing Address);
- (k) during the period of the partial Registration, the Wholesaler shall provide the Market Operator with the SPID Data for which they are the Data Owner (e.g. Landlord SPID relationship);
- (l) the Wholesaler shall provide the Market Operator with the Supply Point Effective From Date;
- (m) following each data submission, the Market Operator will check if sufficient data has been provided to allow the SPID to become Tradable, and will make the SPID Tradable as soon as this is the case; and
- (n) in all cases the Market Operator will notify the relevant Trading Parties of the data provided to it by the Wholesaler and Retailer.

## 2.2 Description of process steps

### Step a: Submit new SPID request

- 2.2.1 The Wholesaler shall issue a request for a new SPID, using Data Transaction T101.W (Request New SPID).
- 2.2.2 The T101.W (Request New SPID) shall include:

- (a) confirmation of whether the New Supply Point relates to Water Services or Sewerage Services;
- (b) the Supply Point address, as known to the Wholesaler at the time;
- (c) confirmation of the type of connection, being either new connection, Gap Site, or Entry Change of Use; and
- (d) identification of the Retailer where this is known.

2.2.3 Where the New Supply Point relates to a Service Category at an Eligible Premises that is not Registered as receiving that Service Category and a Supply Point of the other Service Category at the Eligible Premises is already Registered or in the process of being Registered, the T101.W (Request New SPID) shall identify the Other Wholesaler and include at least one of the following to ensure that the Supply Points can be paired:

- (a) the SPID for the other Service Category; or
- (b) a Pairing Reference Data Item provided by the Wholesaler, which is common to both the New Supply Point and the Supply Point of the other Service Category which is in the process of being Registered. Where no Pairing Reference is provided, a reason must be given.

2.2.4 The T101.W (Request New SPID) shall also include the VOA BA Reference, or the reason for not providing the VOA BA Reference, or it not being unique, or it being different from the VOA BA Reference of the other SPID in the pair if one has been identified; and

2.2.5 The T101.W (Request New SPID) shall also include the UPRN or the reason for not providing the UPRN, or it not being unique, or it being different from the UPRN of the other SPID in the pair if one has been identified.

#### **Step b: Validate new SPID request**

2.2.6 The Market Operator will validate the information provided by the Wholesaler, and will confirm acceptance or rejection using the Data Transaction T109.M (Accept or Reject), within one (1) Business Day of submission of the Data Transaction by the Data Owner.

**Step c: Identify if SPID is paired or confirmation required of any services from Other Wholesaler, and create SPID**

2.2.7 The Market Operator will determine if the new SPID should be linked to another SPID already Registered or in the process of being Registered at the Eligible Premises.

2.2.8 If the new SPID cannot be paired (i.e. the Wholesaler has not identified a SPID of the other Service Category, and not provided a Pairing Reference Data Item which matches another request for a New SPID of the other Service Category, and not provided a valid Pairing Reference Reason Code), but the Wholesaler has identified the Other Wholesaler, the Market Operator will send a request to the Other Wholesaler to confirm if any services are being provided of the other Service Category, using Data Transaction T137.M (Request Confirmation of Any Services). The Other Wholesaler should respond using Data Transaction T137.W (Notify Confirmation of Any Services), and this will be used by the Market Operator to note and report when reporting on unpaired SPIDs. If the Other Wholesaler confirms that services of the other Service Category are being provided and no corresponding Supply Point is Registered, the Other Wholesaler shall Register a New Supply Point for the other Service Category (which for the avoidance of doubt will be treated independently). If the Other Wholesaler confirms that services of the other Service Category are being provided and a corresponding Supply Point is already Registered, the Wholesaler and the Other Wholesaler shall work together to pair the SPIDs in accordance with CSD 0105 (Error Rectification and Retrospective Amendments) once the New Supply Point has become Tradable on completion of the process described in this CSD.

2.2.9 If no Retailer has been identified in the new SPID request, the Market Operator will allocate a Retailer to the Supply Point in accordance with CSD 0005 (Direction to Supply Allocation Process).

Where the Market Operator has allocated a Retailer to the Supply Point in accordance with CSD 0005, the Market Operator will notify the Authority of the allocation.

2.2.10 The Market Operator will create the SPID for the New Supply Point, with a SPID Status of NEW.

#### **Step d: Market Operator sends notifications of new SPID**

- 2.2.11 Within one (1) Business Day of receipt of the T101.W (Request New SPID), the Market Operator will send notification of the SPID to the Wholesaler, Retailer, Other Retailer and Other Wholesaler as relevant using Data Transaction T102.M (Notify New SPID):
- (a) in the case of the notification to the Retailer, this will constitute a request to submit a T103.R (Submit Partial Registration Application/Rejection);
  - (b) in the case of the notification to the Wholesaler, this will constitute a request to submit the data for the Supply Point for which they are the Data Owner.
- 2.2.12 For the avoidance of doubt, the Market Operator will monitor newly created Supply Points in accordance with CSD 0002 (Market Performance Framework) in order to ensure that Partial Registration Applications are received in a timely manner, and that such Partial Registration Applications proceed to completion.

#### **Step e: Retailer submits Partial Registration Application/Rejection**

- 2.2.13 The Retailer shall submit Data Transaction T103.R (Submit Partial Registration Application/Rejection) within five (5) Business Days of the issue of the T102.M by the Market Operator. The T103.R will be either a:
- (a) Partial Registration Application; or
  - (b) notification of rejection where a Retailer considers that it is not the Retailer responsible for the New Supply Point, or where the Retailer believes that the New Supply Point is a duplicate of a SPID already Registered. The Retailer cannot reject the New Supply Point if it applied to the Wholesaler for the connection of the New Supply Point under the Operational Terms.
- 2.2.14 For the avoidance of doubt, if the Supply Point has been allocated to the Retailer via the Direction to Supply Allocation Process as set out in CSD 0005 (Direction to Supply Allocation Process), then the Retailer cannot reject the Supply Point. Should the Retailer have any queries in relation to the Gap Site, these should be progressed with the Wholesaler in accordance with the Deregistration process under the Operational Terms.

2.2.15 In the event that a T103.R (Notify Registration Application/Rejection) has not been received within five (5) Business Days of the Market Operator issuing the T102.M (Notify New SPID) to the Retailer, the Market Operator will escalate the matter on a monthly basis by provision of a report to that Retailer's Contract Manager. Supply Points which have been Deregistered will not be included in the report.

#### **Step f: Market Operator notifies Wholesaler of SPID rejection**

2.2.16 If the Retailer rejects the SPID, the Market Operator will notify the rejection to the Wholesaler using Data Transaction T103.M (Notify Registration Application/Rejection), and the process terminates at this point. Note: From this point the Retailer is not a Data Owner for the SPID, so will not receive any further notifications from the Market Operator in relation to the SPID. The Wholesaler shall either:

- (a) Restart the process by resubmitting the new SPID request, including the details of the rejected SPID; or
- (b) Deregister the SPID in accordance with CSD 0104 (Maintain SPID Data).

#### **Step g: Process Partial Registration Application**

2.2.17 Upon the Market Operator's receipt of the Partial Registration Application, the Retailer so Registered will become the Data Owner for the relevant SPID Data and will be responsible for providing the outstanding SPID Data to the Market Operator in order to complete the Registration.

2.2.18 The Market Operator will update the SPID Status of the SPID to PARTIAL.

2.2.19 While for almost all Supply Points there will be a requirement for the Retailer to submit further SPID Data, in some circumstances involving the addition of a New Supply Point where there is already a Supply Point of the other Service Category at the Eligible Premises, it is possible that at this stage in the process, enough data has already been submitted to complete the Registration. Accordingly, the check described in step s is carried out at this point in the process.

#### Step h: Wholesaler provides Discharge Point data

- 2.2.20 The Wholesaler shall notify the Market Operator in respect of Discharge Points in accordance with CSD 0206 (Trade Effluent Services) using Data Transactions T121.W (Submit DPID), T123.W (Submit Discharge Point Meter Association), T128.W (Submit Trade Effluent Special Agreement) and T168.W (Submit Calculated Discharge Details).
- 2.2.21 The Market Operator will load the data to the Central Systems and provide the data to the Retailer using Data Transactions T121.M (Notify DPID), T123.M (Notify Discharge Point Meter Association), T128.M (Notify Trade Effluent Special Agreement) and T168.M (Notify Calculated Discharge Details) as relevant.

#### Step i: Wholesaler provides Service Component Data

- 2.2.22 The Wholesaler shall notify the Market Operator in respect of the applicable Service Components, and the Tariff to be applied to each active Service Component, using Data Transactions T139.W (Submit Water Services SPID Service Components) and/or T140.W (Submit Sewerage Services SPID Service Components). For the avoidance of doubt, these Data Transactions may be resubmitted prior to the SPID becoming Tradable if the applicable Service Components, and the Tariff to be applied to each active Service Component, need to be modified, and will replace any values previously submitted. After the SPID has become Tradable all such modifications shall be made using Data Transactions in accordance with CSD 0104 (Maintain SPID Data).
- 2.2.23 Following the loading of the Service Components, the Market Operator will carry out the check detailed in step s. If the SPID Data is consistent, then the process will continue at step t, otherwise the Retailer and/or the Wholesaler (as appropriate) will continue to have to load SPID Data.
- 2.2.24 For both a Water Services Supply Point and a Sewerage Services Supply Point, the Wholesaler shall notify the Market Operator in respect of the presence or not of the parameters related to the active Service Components, using Data Transactions T144.W (Submit Unmeasured Service Component Data), T145.W (Submit Assessed Service Component Data), T147.W (Submit Metered Service Component Data), or T163.W (Submit Rateable Value) as relevant.

- 2.2.25 For a Sewerage Services Supply Point, the Wholesaler shall also notify the Market Operator in respect of the presence or not of the parameters related to the active Service Components, using Data Transactions T158.W (Submit Highway Drainage Service Component Data), or T159.W (Submit Surface Water Service Component Data) as relevant.
- 2.2.26 The Wholesaler shall notify the Market Operator of any Special Agreement for each active Service Component using the Data Transaction T129.W (Notify SPID Special Agreement).
- 2.2.27 The Wholesaler shall notify the Market Operator of the Core Data affecting charging associated with the Supply Point, using Data Transaction T149.W (Submit Core Charge Affecting Wholesaler Data). Note: Core Data provided by the Water Services Wholesaler takes precedence over data provided by the Sewerage Services Wholesaler if both Water Services and Sewerage Services are provided at the Eligible Premises.
- 2.2.28 The Wholesaler shall notify the Market Operator of whether or not the SPID has Building Water using Data Transaction T133.W (Update Building Water Status). In the case of a Sewerage Services SPID with a related Water Services meter, the T133.W (Update Building Water Status) must be submitted separately in respect of both the Water Services Supply Point and the Sewerage Services Supply Point. Building Water must be notified for SPIDs irrespective of:
- (a) whether the Building Water is being supplied to premises which will become Household Premises or Eligible Premises;
  - (b) whether the Building Water supply has Metered, Unmeasured or Assessed Service Components; and
  - (c) the means by which Primary Charges are to be calculated, noting that:
    - (i) if Primary Charges are to be calculated using Metered or Assessed volumes, then the Wholesaler shall configure a Metered or Assessed Service Component for the SPID as relevant, and the relevant data shall be submitted to the Market Operator as for any other SPID with Metered or Assessed Service Components, such

that the Central Systems can calculate these as Primary Charges;  
or

- (ii) if Primary Charges are to be calculated by other means outside of the Central Systems (e.g. based on a proportion of the value of the development in line with the Wholesaler's Tariff Document), then the Wholesaler shall configure an Unmeasured Service Component for the SPID with zero charges applying. In this case, Wholesale Charges shall be calculated by the Wholesaler as Non-Primary Charges, outside the Central Systems.

#### **Step j: Market Operator updates Central Systems and notifies Retailer(s) and Other Wholesaler as relevant**

2.2.29 The Market Operator will load the data to the Central Systems and provide the data to the Retailer(s) and the other Wholesaler as relevant using Data Transactions T139.M (Notify Water Services SPID Service Components), T140.M (Notify Sewerage Services SPID Service Components), T129.M (Notify SPID Special Agreement), T144.M (Notify Unmeasured Service Component Data), T145.M (Notify Assessed Service Component Data), T147.M (Notify Metered Service Component Data), T149.M (Notify Core Chargeable Data), T158.M (Notify Highway Drainage Service Component Data), or T159.M (Notify Surface Water Service Component Data), T163.M (Notify Rateable Value) as relevant, and T133.M (Notify Building Water Status).

#### **Step k: Wholesaler provides meter details and Initial Read**

2.2.30 Within five (5) Business Days of meter installation for activities undertaken by the Wholesaler, and eight (8) Business Days of meter installation for activities undertaken by an Accredited Entity, the Wholesaler will notify the Market Operator of the meter details and the Initial Read for each meter installed at the Supply Point, using Data Transaction T104.W (Submit Meter Details). This shall include identifying the Meter Treatment.

2.2.31 Meter Treatment can be one of the following:

- (a) a Potable Water Meter (denoted by POTABLE). A Potable Water Meter can only be added at a Water Services Supply Point;



- (b) a Non-Potable Water Meter (denoted by NONPOTABLE). A Non-Potable Water Meter can only be added at a Water Services Supply Point;
- (c) a Sewerage Meter (denoted by SEWERAGE). A Sewerage Meter can only be added at a Sewerage Services Supply Point;
- (d) a Private Water Meter (denoted by PRIVATEWATER). A Private Water Meter can only be added at a Sewerage Services Supply Point;
- (e) a Private Trade Effluent Meter (denoted by PRIVATETE). A Private Trade Effluent Meter can only be added at a Sewerage Services Supply Point; or
- (f) a Cross Border Meter (denoted by CROSSBORDER). A Cross Border Meter can only be added at a Sewerage Services Supply Point.

2.2.32 For some Meter Treatments, the Wholesaler must not include certain Data Items within Data Transaction T104.W (Submit Meter Details) as follows:

- (a) for a Potable Water Meter ~~or a~~ a Non-Potable Meter or a Non-Market Meter, the Return to Sewer and the Sewerage Chargeable Meter Size shall not be set to any value by the Water Wholesaler submitting the Data Transaction, as the Return to Sewer will be set by the Central Systems to the Default Return to Sewer value for the Sewerage Wholesaler, and Sewerage Chargeable Meter Size will be set to the Physical Meter Size by the Central Systems. These Data Items may subsequently be changed only by the Sewerage Wholesaler;
- (b) for a Private Water Meter or Cross Border Meter, the Water Chargeable Meter Size shall not be set to any value by the Sewerage Wholesaler submitting the Data Transaction, as it will be set to zero (0) by the Central Systems;
- (c) for a Sewerage Meter the Water Chargeable Meter Size and the Return to Sewer shall not be set to any value by the Sewerage Wholesaler submitting the Data Transaction, as it will be set to zero (0) and 100% respectively by the Central Systems; or
- (d) for a Private Trade Effluent Meter, the Water Chargeable Meter Size, Sewerage Chargeable Meter Size and Return to Sewer shall not be set to

any value by the Sewerage Wholesaler submitting the Data Transaction, as they will be set to zero (0) by the Central Systems.

- 2.2.33 The Wholesaler will also include within Data Transaction T104.W (Submit Meter Details) meter location data, data logger flags to indicate the presence or absence of data loggers (or similar device for data capture and transmission) at a meter, the Physical Meter Size and the Meter Addition Reason. The meter location should be notified in the form of Ordnance Survey Great Britain (OSGB) X and Y co-ordinates in an all-numeric format and should also include a Meter Location Code, an address and optionally a free text location description. Likewise, if a meter outreader is installed, the meter outreader location should be notified in the form of OSGB X and Y co-ordinates in an all-numeric format and should also include a Meter Outreader Location Code and optionally a free text location description. Data loggers can be either Wholesaler data loggers or non-Wholesaler data loggers. Both data logger types can be present at a meter at the same time. The Wholesaler will also identify if the meter installation was undertaken by an Accredited Entity. The Physical Meter Size must be provided for Potable Water Meters, Non-Potable Water Meters, Private Water Meters, ~~and~~ Cross Border Meters and Non-Market Meters. Otherwise, the provision of the Physical Meter Size is optional.
- 2.2.34 If the meter has already been installed for another reason (e.g., the meter is a Water Meter associated with the Water Services Supply Point already created at the Eligible Premises, and the New Supply Point being Registered is the Sewerage Services Supply Point), then all the meter details will already have been provided. However, the Sewerage Wholesaler may wish to update the Return to Sewer value and the Sewerage Chargeable Meter Size using Data Transaction T114.W (Update Meter Chargeable).
- 2.2.35 In the event that a meter installed at the Supply Point is in a Meter Network, the Wholesaler shall provide the Market Operator with the Meter Network data using Data Transaction T136.W (Submit Meter Network Data).
- 2.2.36 For a New Supply Point due to Entry Change of Use which already has a Non-Market Meter as a Sub Meter in a Meter Network at another SPID, the Wholesaler shall notify the Market Operator of the association of the meter with the New

Supply Point using Data Transaction T181.W (Submit Association/Disassociation of Meter with SPID).

### **Step i: Market Operator loads meter data and notifies Retailers and Other Wholesaler as relevant**

- 2.2.37 The Market Operator will load the data to the Central Systems and notify the Retailer(s) using Data Transactions T104.M (Notify Meter Details), T136.M (Notify Meter Network Data) and T181.M (Notify Association/Disassociation of Meter with SPID), as relevant.
- 2.2.38 Following the loading of the Initial Read, the Market Operator will carry out the check detailed in step s. If the SPID Data is consistent, then the process will continue at step t, otherwise the Retailer and/or the Wholesaler (as appropriate) will continue to submit SPID Data.

### **Step m: Retailer submits relevant SPID Data**

- 2.2.39 Following the notification of meter(s), the Water Services Retailer may submit the Yearly Volume Estimate (YVE) for meter(s) at the New Supply Point using the Data Transaction T146.R (Submit Yearly Volume Estimate). In the absence of such a submission for Potable Water Meters and Non-Potable Water Meters, the Market Operator will use an appropriate value from the Industry Level Estimate Table.
- 2.2.40 The Retailer may provide the Market Operator with details of the occupancy status of the Eligible Premises using Data Transaction T112.R (Update Occupancy Status). If the Retailer does not provide details of the occupancy status of the Eligible Premises, the Market Operator will consider the Eligible Premises to be occupied, in respect of the first SPID at an eligible premise. Any further SPIDs at this premise will inherit the occupancy status of the first SPID.
- 2.2.41 The Retailer may provide the Market Operator with details of the billing address of the Non-Household Customer at the Eligible Premises, using Data Transaction T156.R (Update Billing Address). For the avoidance of doubt, if the Retailer does not submit billing address information, this does not prevent the SPID from becoming Tradable; however the Retailer shall submit any changes to this data to

the Market Operator within five (5) Business Days of becoming so aware, as described in CSD 0104 (Maintain SPID Data).

- 2.2.42 For a metered Supply Point, the Retailer may provide the Market Operator with the Retailer owned details of the meter location, using Data Transaction T160.R (Update Retailer Meter Location Data). For the avoidance of doubt, if the Retailer does not submit meter location information, this does not prevent the SPID from becoming Tradable, however the Retailer shall submit any changes to this data to the Market Operator within five (5) Business Days of becoming so aware, as described in CSD 0104 (Maintain SPID Data).

#### **Step n: Market Operator loads relevant SPID Data**

- 2.2.43 The Market Operator will load the data to the Central Systems and notify it to the Wholesaler(s) and Other Retailer as relevant using Data Transactions T146.M (Notify Yearly Volume Estimate), T112.M (Notify Occupancy Status) and T160.M (Notify Retailer Meter Location Data).
- 2.2.44 The Market Operator will load the billing address data to the Central Systems but will not notify any other Trading Parties of this information.

#### **Step o: Provide Customer Name**

- 2.2.45 If not already provided as Core Data for any other Supply Point already Registered at the Eligible Premises, the Retailer shall also submit the customer name, and if known, customer classification and SIC Code data for the New Supply Point using Data Transaction T132.R (Submit Core Customer Data). Note: Core Data provided by the Water Services Retailer takes precedence over Core Data provided by the Sewerage Services Retailer if both Water Services and Sewerage Services are provided at the Eligible Premises.
- 2.2.46 Where the Sewerage Services Supply Point has an associated Water Supply Point, Core Data notified in error by the Sewerage Services Retailer will receive a T109.M (Accept or Reject) rejection from the Market Operator.

#### **Step p: Market Operator loads Core Data**

- 2.2.47 The Market Operator will load the data to the Central Systems and notify the Wholesaler(s) and Other Retailer as relevant.

2.2.48 Following the loading of a customer name, the Market Operator will carry out the check detailed in step s. If the SPID Data is consistent, then the process will continue at step t, otherwise the Retailer and/or the Wholesaler (as appropriate) will continue to submit SPID Data.

**Step q: Submit Supply Point Effective From Date**

2.2.49 This step may be carried out before or after the Wholesaler completes step h, step i and step k as applicable. The Wholesaler is always responsible for providing the Supply Point Effective From Date at the Supply Point.

2.2.50 For a New Supply Point which is a new connection:

- (a) the Wholesaler will notify the Market Operator of the Supply Point Effective From Date, which will be the date of connection of the Supply Point, using Data Transaction T107.W (Submit Notification of Connection Complete). The Wholesaler must submit this transaction within five (5) Business Days of the date of connection for activities undertaken by the Wholesaler, and eight (8) Business Days of the date of connection for activities undertaken by an Accredited Entity; and
- (b) as part of the T107.W (Submit Notification of Connection Complete), the Wholesaler shall also identify whether the connection has been made by an Accredited Entity.

2.2.51 For a New Supply Point which is a Gap Site or Entry Change of Use, the Wholesaler will notify the Market Operator of the Supply Point Effective From Date, using Data Transaction T107.W (Submit Notification of Connection Complete). The Supply Point Effective From Date in the transaction must be five (5) Business Days after the date on which the Market Operator confirmed the SPID using the Data Transaction T102.M (Notify New SPID). The Wholesaler must submit this transaction within five (5) Business Days of the Supply Point Effective From Date, so in effect this transaction shall be submitted no later than ten (10) Business Days after the date on which the Market Operator confirmed the SPID using the Data Transaction T102.M (Notify New SPID).

### Step r: Notify Supply Point Effective From Date

- 2.2.52 The Market Operator will notify the Retailer(s) and Other Wholesaler of the Supply Point Effective From Date using Data Transaction T107.M (Notify Connection Complete).
- 2.2.53 Following the loading of a Supply Point Effective From Date, the Market Operator will carry out the check detailed in step s. If the SPID Data is consistent, then the process will continue at step t, otherwise the Retailer and/or the Wholesaler (as appropriate) will continue to have to load SPID Data.

### Step s: Verify SPID Data consistent

- 2.2.54 The Market Operator will run a validation check as detailed in Appendix A to verify that the SPID Data is consistent following the successful submission of any of:
- (a) T103.R (Submit Partial Registration Application/Rejection);
  - (b) T139.W (Submit Water Services SPID Service Components);
  - (c) T140.W (Submit Sewerage Services SPID Service Components);
  - (d) T121.W (Submit DPID);
  - (e) T104.W (Submit Meter Details);
  - (f) T132.R (Submit Core Customer Data); and
  - (g) T107.W (Submit Notification of Connection Complete);
- 2.2.55 The check will confirm that the SPID has:
- (a) a SPID Status of PARTIAL;
  - (b) at least one valid Service Component and associated Tariff on the Supply Point Effective From Date;
  - (c) an associated meter with an Initial Meter read on or before the Supply Point Effective From Date, if the SPID has any metered Service Component; and

(d) a customer name associated with it. Note: If the Eligible Premises is vacant the Customer Name Data Item associated with the SPID must be populated with “No Customer”.

2.2.56 In the event that this check is successful, the Registration is complete, the SPID Status will be set to TRADABLE and the SPID will be included in the Settlement Process.

**Step t: Make SPID Tradable**

2.2.57 When the Registration of a SPID is complete, the Market Operator will notify the Wholesaler(s) and the Retailer(s) as relevant that the SPID is Tradable using Data Transaction T135.M (Tradability Notification).

2.2.58 The absence of such notifications will mean that the validation check was unsuccessful, and that the SPID is not yet Tradable.

### 3. Monitoring, reporting, correcting and completing the Registration of New Supply Points

#### 3.1 Monitoring and reporting

3.1.1 In accordance with CSD 0302 (Standing Reports and Data Extracts), the Market Operator shall provide the Trading Parties with the New and Partial SPIDs report (known as NAPS) which contains information about SPID Status.

3.1.2 The Market Operator will monitor all partial Registrations in accordance with CSD 0002 (Market Performance Framework).

#### 3.2 Correcting and completing the Registration of New Supply Points

3.2.1 It is the responsibility of each Trading Party to monitor the NAPS report, and to submit appropriate data so that the SPID can be made Tradable.

3.2.2 If a SPID has been Registered in error, it is the responsibility of the Wholesaler to submit an appropriate T115.W (Declare Disconnection/Reconnection/Deregistration) Data Transaction to Deregister the SPID.



## 4. Process Diagrams

### New Supply Point – Page 1 of 3

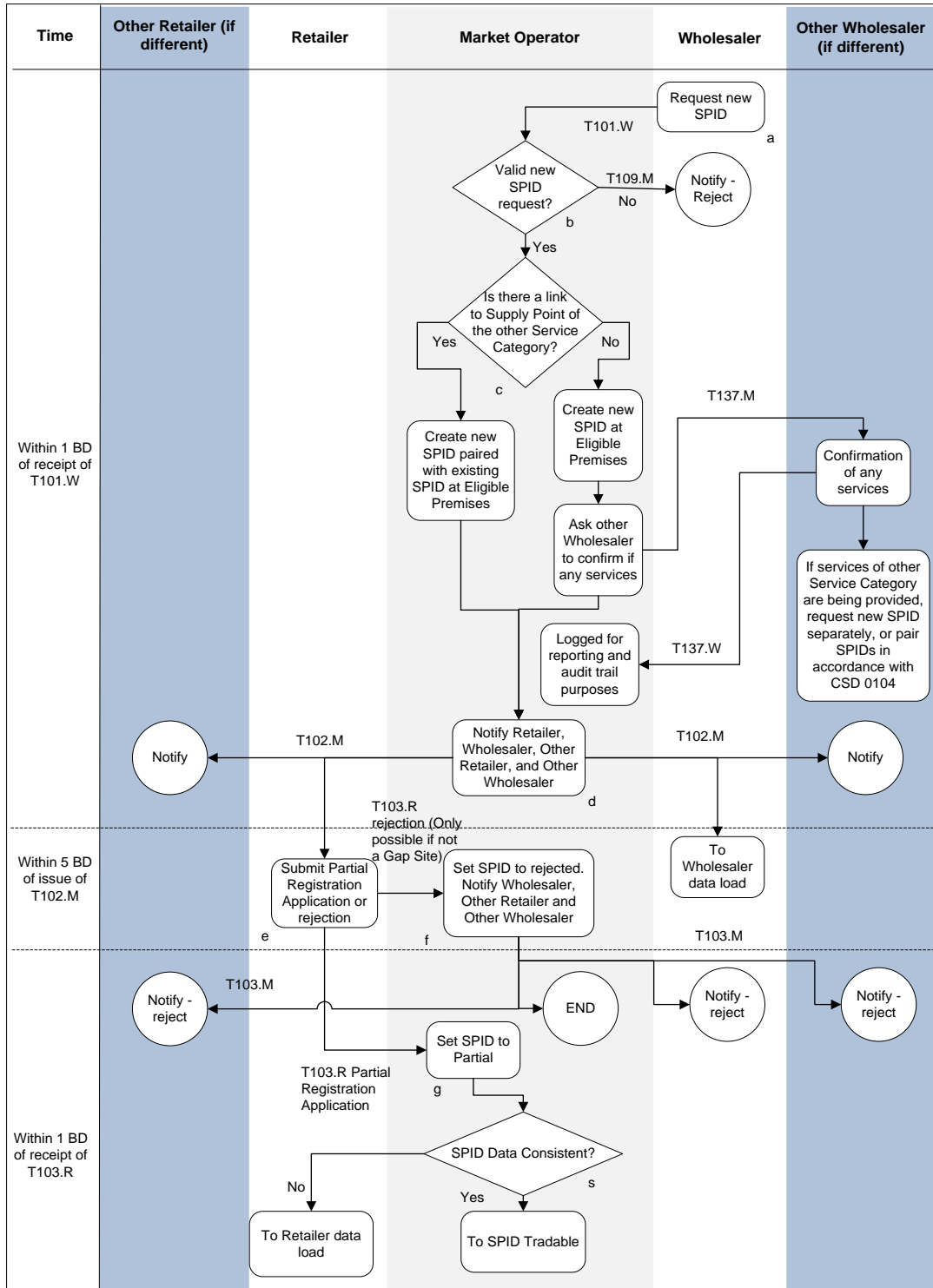

New Supply Point – Page 2 of 3

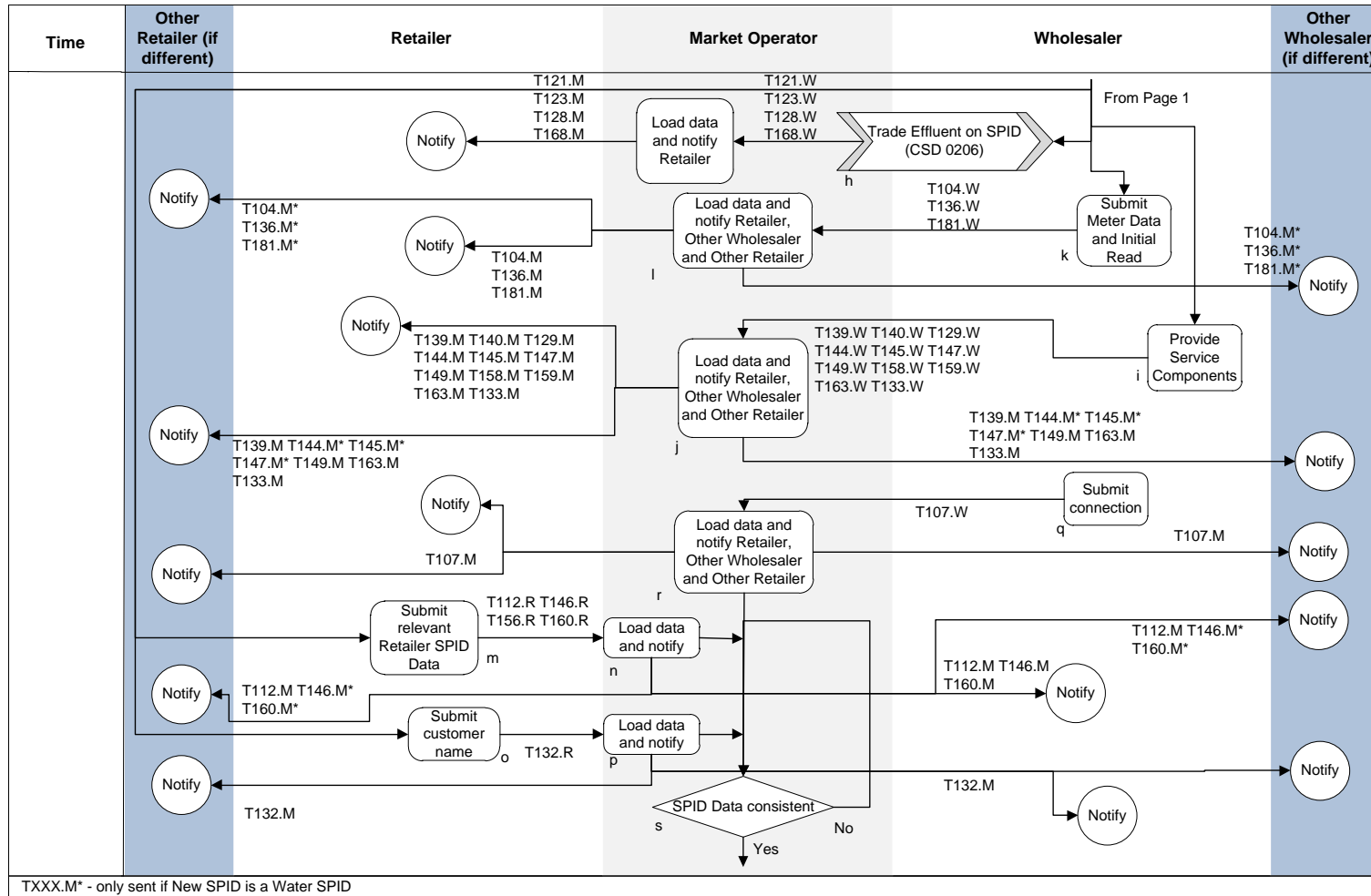

New Supply Point - Page 3 of 3

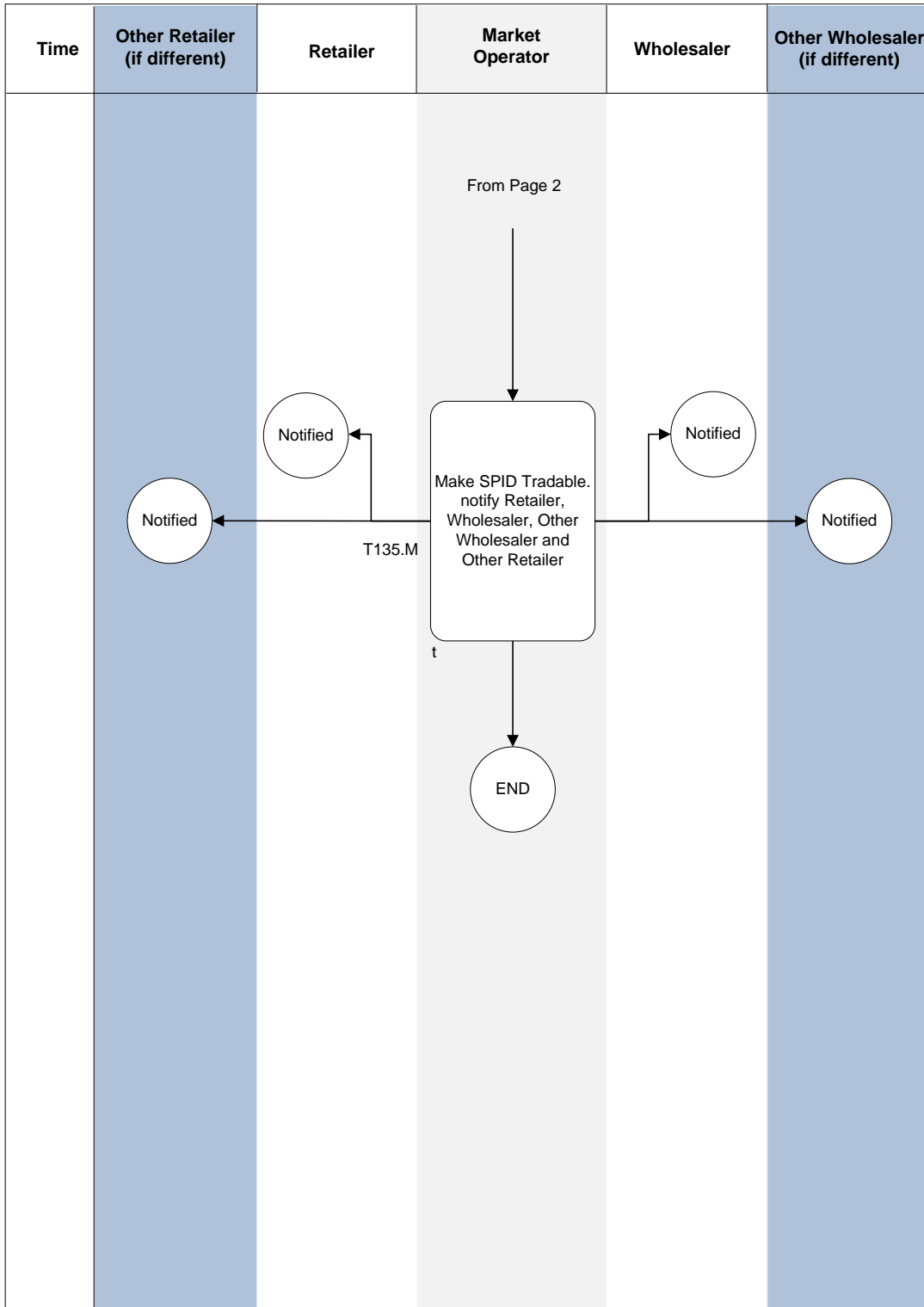

## 5. Interface and timetable requirements

Step	Action/ Decision	Process Step	From	To	Time parameter	Comments	Data Transaction
a	A	Submit request for New SPID	Wholesaler	Market Operator	In accordance with Operational Terms		T101.W
b	D	Market Operator validates transaction	Market Operator	Wholesaler	Within 1 BD of receipt of T101.W		T109.M
c	D/A	Identify if SPID can be paired. If not, and no valid Pairing Reference Reason Code provided, and Other Wholesaler is identified, ask Other Wholesaler to confirm if any Water Services or Sewerage Services provided, as relevant.  Allocate Retailer using Direction to Supply Allocation Process if none identified.  Create SPID.	Market Operator	Other Wholesaler	Within 1 BD of receipt of T101.W		T137.M

Step	Action/ Decision	Process Step	From	To	Time parameter	Comments	Data Transaction
d	A	Notify Wholesaler, Retailer, Other Retailer (if different) and Other Wholesaler (if different and not already asked to confirm if any Water Services or Sewerage Services)	Market Operator	Wholesaler, Other Wholesaler, Retailer, Other Retailer	Within 1 BD of receipt of T101.W		T102.M
e	A	Submit Partial Registration Application	Retailer	Market Operator	Within 5 BD of issue of T102.M		T103.R
e	A	Submit rejection of Partial Registration Application	Retailer	Market Operator	Within 5 BD of issue of T102.M		T103.R
f	A	Set SPID Status to REJECTED. Send back to Wholesaler. Notify Other Retailer and Other Wholesaler as relevant.	Market Operator	Wholesaler, Other Wholesaler, Other Retailer	Within 1 BD of receipt of T103.R		T103.M
g	A	Process Partial Registration Application Check if SPID Data consistent (step s)	Market Operator		Within 1 BD of receipt of T103.R		

Step	Action/ Decision	Process Step	From	To	Time parameter	Comments	Data Transaction
h	A	Submit Discharge Point data	Wholesaler	Market Operator			T121.W T123.W T128.W T168.W
h	A	Notify Discharge Point data	Market Operator	Retailer	Within 1 BD of receipt of T121.W, T123.W, T128.W or T168.W		T121.M T123.M T128.M T168.M
i	A	Provide Service Components Check if SPID Data consistent (step s) Provide Service Component Data Provide Special Agreement information Provide Core Data affecting charging	Wholesaler	Market Operator			T139.W T140.W T129.W T144.W T145.W T147.W T149.W T158.W T159.W T163.W T133.W

Step	Action/ Decision	Process Step	From	To	Time parameter	Comments	Data Transaction
j	A	Load data and notify Retailer, Other Wholesaler and Other Retailer as relevant	Market Operator	Other Wholesaler, Retailer, Other Retailer	Within 1 BD of receipt of relevant transaction		T139.M T149.M T163.M T133.M
				Other Wholesaler (unless Other Wholesaler is Water), Retailer, Other Retailer (unless Other Retailer is Water)			T144.M T145.M T147.M
				Retailer			T129.M T140.M T158.M T159.M

Step	Action/ Decision	Process Step	From	To	Time parameter	Comments	Data Transaction
k	A	Provide meter details, Initial Read, Association / Disassociation of meter with SPID and Meter Network data	Wholesaler	Market Operator			T104.W T136.W T181.W
l	A	Validate and load data and notify Retailer, Other Wholesaler and Other Retailer as relevant of meter details, meter read, Association / Disassociation of meter with SPID and meter Network data  Check if SPID data consistent (step s)	Market Operator	Other Wholesaler (unless Other Wholesaler is Water), Retailer, Other Retailer (unless Other Retailer is Water)	Within 1 BD of receipt of relevant transaction		T104.M T136.M T181.M
m	A	Submit Yearly Volume Estimate, occupancy status, meter location data and billing address	Retailer	Market Operator			T146.R T112.R T156.R T160.R



Step	Action/ Decision	Process Step	From	To	Time parameter	Comments	Data Transaction
n	A	Validate and load Yearly Volume Estimate, occupancy status, meter location data and notify Wholesaler(s) and Other Retailer as relevant	Market Operator	Wholesaler, Other Wholesaler (unless Other Wholesaler is Water), Other Retailer (unless Other Retailer is Water)	Within 1 BD of receipt of relevant transaction		T146.M T160.M
				Wholesaler, Other Wholesaler, Other Retailer, Incoming Retailer			T112.M
n	A	Validate and load billing address data	Market Operator		Within 1 BD of receipt of relevant transaction	No notifications are issued	
o	A	Provide customer name	Retailer	Market Operator			T132.R
p	A	Validate and load data and notify Wholesaler(s) and Other Retailer as relevant	Market Operator	Wholesaler, Other Wholesaler, Other Retailer	Within 1 BD of receipt of T132.R		T132.M

Step	Action/ Decision	Process Step	From	To	Time parameter	Comments	Data Transaction
q	A	Submit Supply Point Effective From Date	Wholesaler	Market Operator	New connection: Within five (5) Business Days of the date of connection for activities undertaken by the Wholesaler, and eight (8) Business Days of the date of connection for activities undertaken by an Accredited Entity.  Entry Change of Use or Gap Site: no later than ten (10) Business Days after receiving the T102.M		T107.W
r	A	Validate and load data and notify Retailer(s) and Other Wholesaler as relevant	Market Operator	Other Wholesaler, Retailer, Other Retailer	Within 1 BD of receipt of T107.M		T107.M
s	D	Verify SPID Data consistent	Market Operator				

Step	Action/ Decision	Process Step	From	To	Time parameter	Comments	Data Transaction
t	A	Make SPID Tradable; notify Wholesaler, Other Wholesaler, Retailer and Other Retailer as relevant	Market Operator	Wholesaler, Other Wholesaler, Retailer, Other Retailer			T135.M

## A. Appendix: Validation checks

### A.1 Introduction

A.1.1 A number of validation checks occur in the Central Systems during the processes described in this CSD. These are detailed here. The intention of this appendix is to provide a list of checks, in order to facilitate the Data Owner providing the data in full and in the correct timeframe.



A.1.2 The validation checks identified here do not include the basic validation checks against the Data Transactions and Data Items as defined in CSD 0301 (Data Catalogue) i.e. population of all required Data Items, checking that relevant Data Items conform to the valid set, and type checking of all Data Items.

### A.2 Validation

Step	Data Owner	Transaction	Market Operator data validation
b	Wholesaler	T101.W	Retailer licensed for Service Category in Wholesaler's Area; Valid Pairing Reference Reason Code provided, if no Pairing Reference provided Valid Reason Code provided; if: no VOA BA Reference, or VOA BA Reference is different to the paired SPID if one has been identified; Valid Reason Code provided; if: no UPRN,

Step	Data Owner	Transaction	Market Operator data validation
			or UPRN is different to the paired SPID if one has been identified. <a href="#">Valid Reason Code provided.</a>
f	Retailer	T103.R	SPID has SPID Status of NEW SPID is not a Gap Site
g	Retailer	T103.R	Retailer licensed for Service Category in Wholesaler's Area SPID has SPID Status of NEW
l	Wholesaler	T139.W T140.W	SPID has SPID Status of PARTIAL All Service Components switched on have valid Tariffs
o	<del>Retailer</del> Wholesaler	T132. <del>R</del> W	customer name is in a valid format
s		Various	SPID Status must be PARTIAL At least one valid Service Component and associated Tariff is associated with the SPID on the Supply Point Effective From Date There is an associated meter with an Initial Read on or before the Supply Point Effective From Date, if the SPID has any metered Service Component SPID has a customer name associated with it.

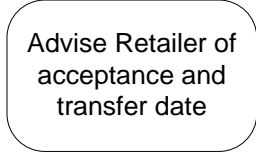
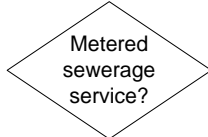
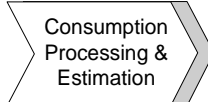
## B. Appendix: process flowchart symbols

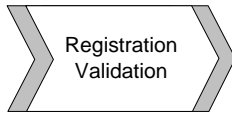
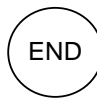
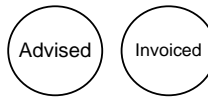
Symbol	Name	Details
	Action	An action step. It appears in the “swimlane” of the party responsible for performing the action.
	Decision	A decisive question rather than an action. Followed by Yes or No, or occasionally Water Services or Sewerage Services, the process splits depending on the answer to the question in the decision diamond.
	To another process	A flow in, or input to, another documented process
	From another process	A flow in, or output from another documented process.
	To and from another process	Used where a process is embedded within another. At this point, go to the embedded process chart before returning to the one in which it is embedded.
	End	Used after a decision diamond, generally to mean “do nothing” as it is the end of the process.
	Advised/Invoiced	Used after a process step to show “passive” action on the part of a Data Transaction receiver e.g. to represent “Advised” or “Invoiced”
<i>g</i>	Action/Decision reference	An alphabetic reference beside each step and decision. This reference appears on the table in each section to facilitate reading the table against the process flowcharts.
T115.W	Transaction reference	Reference to the Data Transaction occurring as an output from the step it appears next to.